

# Filter Regulator

## IW Series

- Two types are available: adjustable set pressure type and fixed set pressure type.
- Low/High temperature and external parts copper-free types can be selected.
- Pressure gauge connecting direction: 2 directions (Front/Back)
- Weight: 0.66 kg (Adjustable type), 0.58 kg (Fixed type)



### How to Order

**IW 2 1 2 - 02 -**

Filter regulator •

**Type of setting**

1	Adjustable type (Knob)
2	Fixed type (0.14 MPa)

**Set pressure**

2	0.02 to 0.2 MPa
3	0.02 to 0.3 MPa
5	0.02 to 0.5 MPa

\* Fixed type is IW222 only.

**Accessories**

Nil	None
B	With bracket
G	With pressure gauge

**Port size**

02	1/4
----	-----

**Thread type**

Nil	Rc
N	NPT*

\* Semi-standard

**Suffix**

	Low temperature (-30 to 60°C)	High temperature* (-10 to 100°C)	External parts copper-free
Nil	—	—	—
T	—	●	—
L	●	—	—
S	—	—	●
ST	—	●	●
SL	●	—	●

\* With pressure gauge type: Max. 80°C.

### Standard Specifications

Model	IW212	IW213	IW215	IW222
	Adjustable type (Basic)			Fixed type
Maximum supply pressure	Max. 1.0 MPa			0.3 to 1.0 MPa
Set pressure	0.02 to 0.2 MPa	0.02 to 0.3 MPa	0.02 to 0.5 MPa	0.14 MPa
Air consumption (At maximum set pressure)	1 L/min (ANR) or less			0.5 L/min (ANR) or less
Ambient and fluid temperature	-10 to 60°C (No freezing)			
Filtration accuracy	5 μm			
Port size	Rc1/4			
Pressure gauge port	Rc1/4 (2 locations)			
Weight	0.66 kg			0.58 kg

**Flow Rate Characteristics (Representative values)**

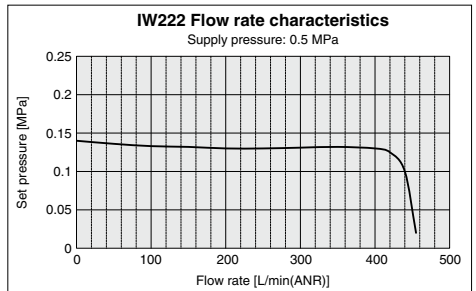
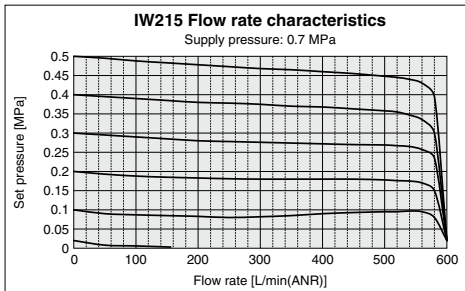
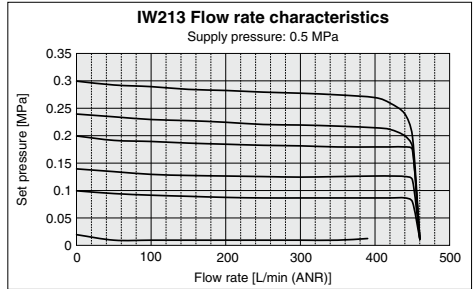
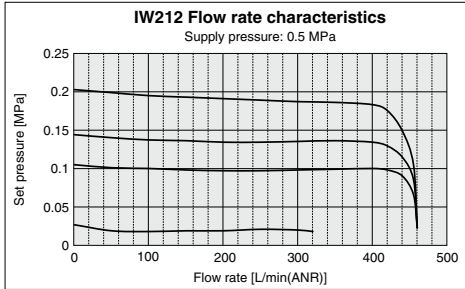

**Pressure Characteristics (Representative values)**

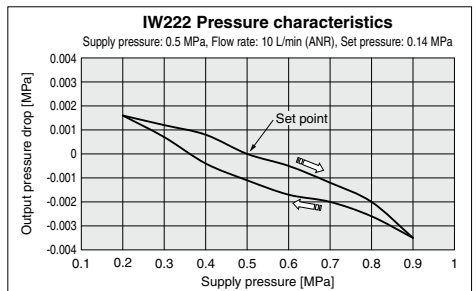
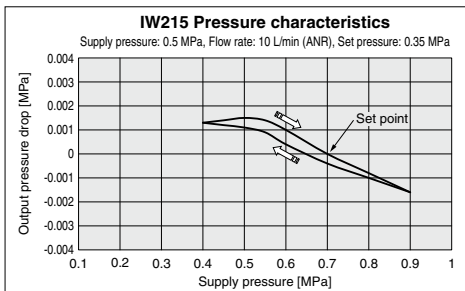
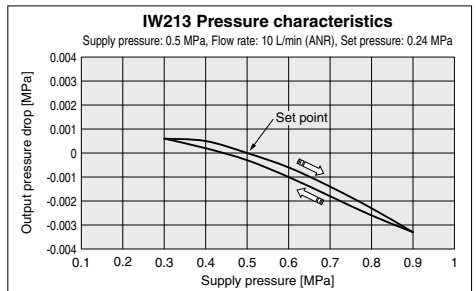
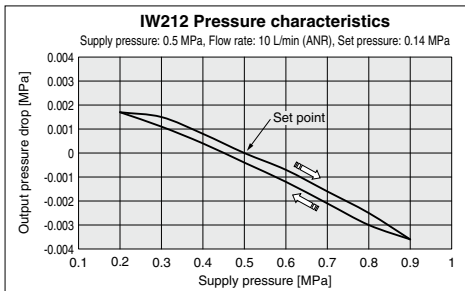

- IP
- IW**
- 1301
- AW
- IL1
- IL2
- IT
- CP
- IS
- VFN
- IN-
- T

## Principle of Operation

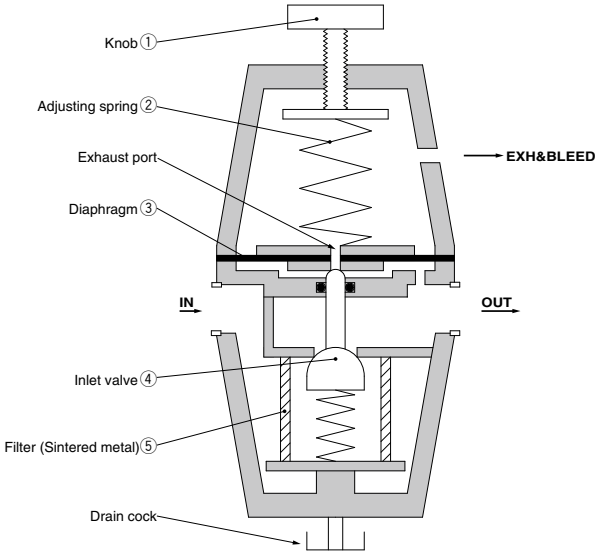

Air flow from the inlet passes through filter (sintered metal) ⑤ where solids are removed. When knob ① is adjusted downwards, adjusting spring ② is compressed. The inlet valve ④ is opened allowing air flow to the outlet. Air outlet pressure balances against diaphragm ③ and adjusting spring ②. When the outlet pressure is higher than the set pressure, the inlet valve ④ is closed and exhaust of the excess outlet pressure takes place through the adjusting spring cover bleed. This ensures constant outlet pressure is maintained.

## Construction

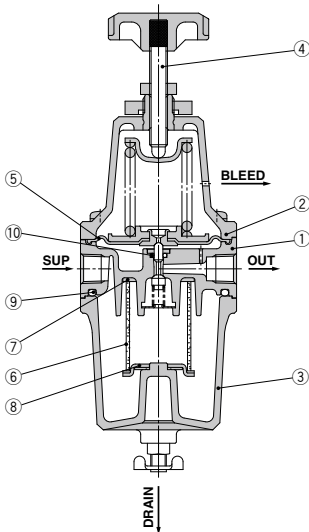

### Component Parts

No.	Description	Material	Note
1	Body assembly	Aluminum die-casted/Aluminum	Silver color
2	Bonnet	Aluminum die-casted/Brass	Silver color
3	Bowl assembly	Aluminum die-casted/Brass	Silver color
4	Knob	ABS/Stainless steel	—

### Replacement Parts

No.	Description	Material	Part no.
5	Diaphragm assembly	Aluminum die-casted/Brass/NBR	P218010-1
6	Element	Bronze	1301111-5B
7	Seal	NBR	1301510
8	Filter disk assembly	Brass/NBR	P218010-16
9	O-ring	NBR	AS568-228
10	O-ring	NBR	JISB2401 P4

**Dimensions**

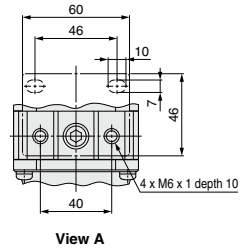
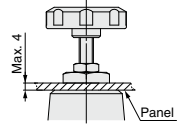
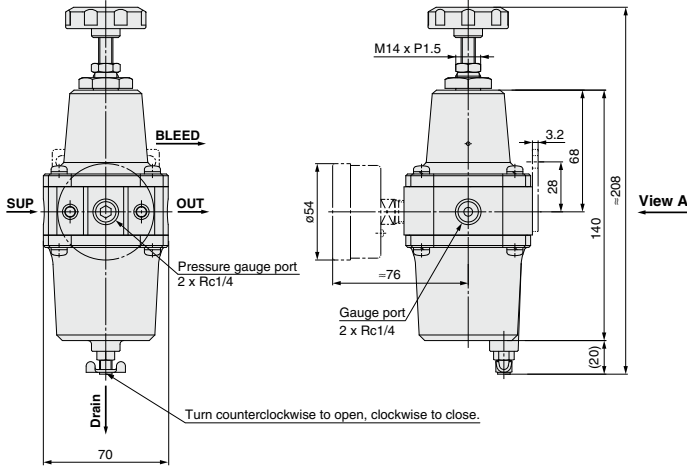

<b>IP</b>
<b>IW</b>
<b>1301</b>
<b>AW</b>
IL1 <input type="checkbox"/>
IL2 <input type="checkbox"/>
IT
CP <input type="checkbox"/>
<b>IS</b>
<b>VFN</b>
IN- T <input type="checkbox"/>

# Filter Regulator 1301 Series

- External main parts: Stainless steel type is available.
- Low temperature/High temperature type is available.  
(Made-to-Order products of the AW series on page 161)



## How to Order

**1301 - 002**   

Filter regulator      Accessories

**Set pressure**

<b>002</b>	0.02 to 0.2 MPa
<b>1202</b>	0.02 to 0.29 MPa
<b>2502</b>	0.02 to 0.49 MPa
<b>902*</b>	0.02 to 0.2 MPa

<b>NII</b>	None
<b>B</b>	With bracket
<b>G</b>	With pressure gauge

\* External main parts are made of stainless steel. For details, refer to page 159.

## Standard Specifications

Model	Basic type			External main parts: Stainless steel
	1301-002	1301-1202	1301-2502	1301-902
Maximum supply pressure	Max. 1.0 MPa			
Set pressure	0.02 to 0.2 MPa	0.02 to 0.29 MPa	0.02 to 0.49 MPa	0.02 to 0.2 MPa
Ambient and fluid temperature	-5 to 60°C (No freezing)			
Filtration accuracy	5 μm			
Port size	Rc1/4			
Pressure gauge port	Rc1/8 (1 location)			
Weight	1.07 kg			

## Flow Rate Characteristics (Representative values)

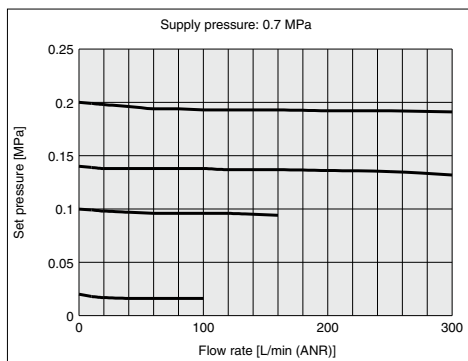

## Pressure Characteristics (Representative values)

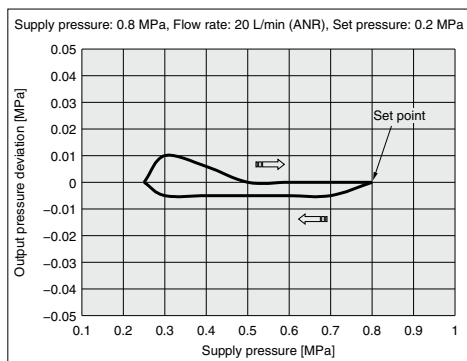

**Principle of Operation**

**1301**

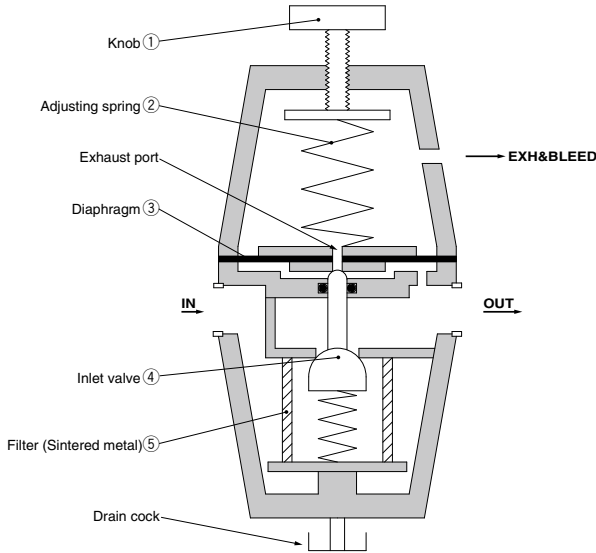

Air flow from the inlet passes through filter (sintered metal) ⑤ where solids are removed. When knob ① is adjusted downwards, adjusting spring ② is compressed. The inlet valve ④ is opened allowing air flow to the outlet. Air outlet pressure balances against diaphragm ③ and adjusting spring ②. When the outlet pressure is higher than the set pressure, the inlet valve ④ is closed and exhaust of the excess outlet pressure takes place through the adjusting spring cover bleed. This ensures constant outlet pressure is maintained.

**Construction**

**1301**

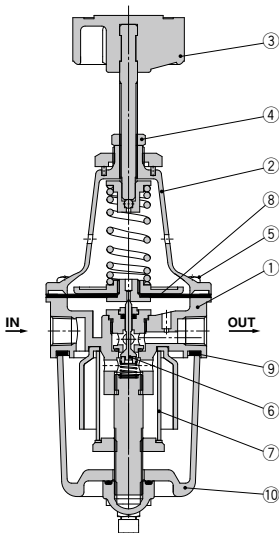

**Component Parts**

No.	Description	Material				Note
		Basic type			External main parts: Stainless steel	
		1301-002	1301-1202	1301-2502		
1	Decompression chamber	Zinc die-casted				Silver color
2	Bonnet	Zinc die-casted				Silver color
3	Knob	ABS/Brass		ABS/Stainless steel		—
4	Lock nut	Brass		Stainless steel		—
5	Round head Phillips screw	Brass		Stainless steel		—

**Replacement Parts**

No.	Description	Material	Part no.			
			Basic type			External main parts: Stainless steel
			1301-002	1301-1202	1301-2502	
6	Pilot valve	Stainless steel/NBR	1301207#1			1301207#1
7	Element	Bronze	1301111-5B			1301111-5B
8	Diaphragm assembly	Weather resistant NBR/Brass/ADC	13014A			13014A
9	Bowl seal	NBR	130124			130124
10	Bowl assembly	ZDC/Brass	130191A			—
		ZDC/Stainless steel	—			130191A-S

- IP
- IW
- 1301**
- AW
- IL1
- IL2
- IT
- CP
- IS
- VFN
- IN-
- TI

# 1301 Series

## Dimensions

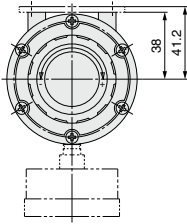

View A

Model	1301-002(BG) 1202(BG), 2502(BG)	1301-902(BG)
Dimensions		

Panel mounting hole	Horizontal mounting	Vertical mounting

